

# DEVELOPMENTS IN SOLAR PHOTOCATALYSIS FOR DESTRUCTION OF ORGANICS IN WATER\*

James E. Pacheco  
Solar Thermal Collector Technology  
Division 6216  
Sandia National Laboratories  
Albuquerque, NM 87185

Cliff Carwile  
U.S. Department of Energy  
Forrestal Building  
Code CE-33  
1000 Independence Avenue, SW  
Washington, DC 20585

Kimberly A. Magrini and Mark Mehos  
Solar Energy Research Institute  
1617 Cole Boulevard  
Golden, CO 80401

## ABSTRACT

We are developing a process that has the potential to destroy a wide range of organic contaminants in water using solar energy and a titanium dioxide photocatalyst,  $\text{TiO}_2$ . Contaminated water flows through a reactor on which sunlight is focused to activate the catalyst forming hydroxyl radicals and super oxide ions. These reactive species readily attack and decompose organics in solution producing only water,  $\text{CO}_2$  and halo acids. Tests have been conducted at three levels: at a benchtop scale (1 liter), with a small outdoor trough (100 liters) and with a large outdoor parabolic trough (2000 liters). The experimental variables examined include ultraviolet light intensity, catalyst loading, the effect of adding hydrogen peroxide, and the performance of catalyst supports. The intensity of ultraviolet irradiation significantly affected decomposition rates of a chlorinated solvent, trichloroethylene (TCE) yielding faster reaction rates at higher intensities. The amount of catalyst in suspension affected the destruction rate of trichloroethylene; the rate increased as the amount of catalyst was increased from 0.01 to 0.1 wt%. Hydrogen peroxide used in conjunction with  $\text{TiO}_2$  significantly enhanced the photocatalytic decomposition rate of a model compound, salicylic acid, by as much as 8 times over the rate with  $\text{TiO}_2$  alone. Supported  $\text{TiO}_2$  on silica glass beads performed less effectively compared to suspended  $\text{TiO}_2$  for TCE decomposition with simulated sunlight as did  $\text{TiO}_2$  on alumina ceramic frits for decomposing salicylic acid in natural sunlight.  $\text{TiO}_2$  on fiberglass mesh performed about as well as the ceramic frits.

## BACKGROUND

Photocatalytic oxidation of organic compounds in water has been investigated extensively for about a decade and a half (1-20). We are developing a process that has the potential to destroy organic pollutants in large volumes of water with sunlight as the light source. With this process, water, containing low concentrations (ppm range) of contaminants, flows through a reactor that contains the semiconductor photocatalyst, titanium dioxide ( $\text{TiO}_2$ ). The titanium dioxide absorbs high energy photons from the incident sunlight to produce surface holes and electrons that react with dissolved oxygen or oxidants in the water to generate hydroxyl radicals ( $\text{OH}^\bullet$ ) and superoxide ions ( $\text{O}_2^-$ ) (2,3). In laboratory studies, these reactive species have been shown to completely oxidize a wide range of organic

chemicals including chlorinated solvents, polychlorinated biphenyls (PCBs), dioxins, pesticides, and dyes yielding only carbon dioxide, water, and dilute mineral acids such as HCl as the final oxidation products (4-12). An advantage of this process over conventional treatment processes such as air stripping or carbon adsorption is that the contaminants are completely destroyed rather than transferred from one phase or medium to another.

We are using three systems to conduct our development work: a benchtop laboratory-scale system, a small outdoor trough system - both at the Solar Energy Research Institute (SERI), and a large-scale trough system - located at Sandia National Laboratories (SNL). With these systems, we are investigating the effects of process variables such as light intensity, catalyst type and concentration, oxidants, pH, contaminant concentration and temperature on the pho-

\* This work is supported by the U.S. Department of Energy under contract DE-AC04-76DP00789.

tocatalytic reaction. We are also comparing the performances of suspended  $\text{TiO}_2$  catalyst to fixed  $\text{TiO}_2$  on various supports. The goal of this work is to demonstrate and field test the technology at a remediation site in the early 1990's.

## EXPERIMENTAL SYSTEMS AND METHODS

### Laboratory System

The laboratory system consists of a recirculating batch photoreactor fabricated from Pyrex, quartz, Teflon, and Viton components and uses a solar simulator as the light source. The bulk of the fluid is held in two 500 ml bulbs. Figure 1 is a schematic of the laboratory setup. The simulated-solar radiation was provided by an Optical Radiation Corporation solar simulator (model SS-1000) equipped with a 1000-W, high-pressure Xenon arc lamp, a Schott WG-305 glass filter, and a dichroic primary reflector. The output is approximately thirty-five times the intensity of sunlight in the wavelength band from 290 to 450 nm. Both suspended and supported  $\text{TiO}_2$  was used as a photocatalyst in this system. Recirculation was provided by a peristaltic pump with adjustable flow rates to 1.8 l/min. To prevent settling of suspended  $\text{TiO}_2$ , stirring was necessary in both of the 500 ml reservoir bulbs. Constant solution temperature was maintained by immersion of the cooling coils in an ethylene glycol-water cooled bath. The data were expressed to represent exposure time,  $t_{\text{exp}}$ ; the amount of time each fluid element spent in the illuminated portion of the quartz photoreactor. The exposure time was calculated from Eq. 1.

$$t_{\text{exp}} = t_{\text{total}} V_{\text{illum}} / V_{\text{sys}} \quad (\text{Eq. 1})$$

where  $t_{\text{total}}$  is the total reaction time in minutes,  $V_{\text{illum}}$  is the illuminated volume (30 ml) of the quartz photoreac-

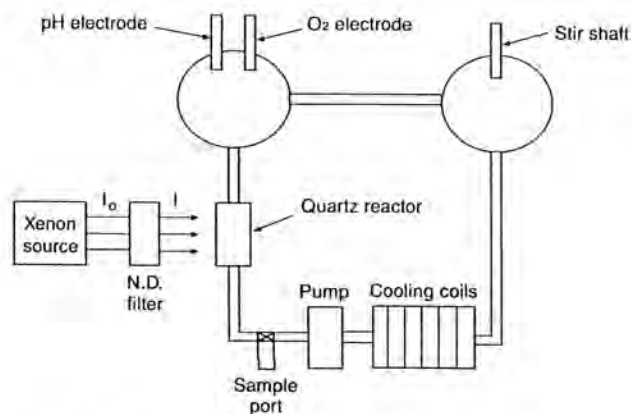

Fig. 1. Benchtop System. Recirculating Batch Photoreactor for Conversion of Organic Compounds.

tor, and  $V_{\text{sys}}$  is the total volume of the recirculating batch system (1 liter).

A limited number of benchtop experiments were conducted at SNL under natural (total global horizontal) sunlight to assess the performance of immobilized catalysts. Two types of immobilized catalyst were assessed on their ability to decompose a nonvolatile organic compound, salicylic acid. Pyrex brand petri dishes were used as the reactor vessel on top of a slow moving shaker table to mix the solution. In these experiments, the fixed supports were placed in the petri dishes which contain 100 ml of solution and are mounted to the shaker table. The supports were exposed to natural sunlight at approximately solar noon for one hour after which the concentration of salicylic acid was measured.

### Small Scale Outdoor Trough

The purpose of the small scale outdoor trough system is to investigate the photodecomposition of aqueous hazardous wastes under available solar conditions while maintaining control of variables important to the process. This allows near duplication of conditions found in the bench-scale experiments. A diagram of the small scale apparatus is presented in Fig. 2. The apparatus consists of a  $3.5 \text{ m}^2$  ( $40 \text{ ft}^2$ ) parabolic trough that illuminates a 38 mm (1.5 in) I.D. borosilicate glass tube reactor. Water, contaminants, and titanium dioxide are mixed in a thirty gallon tank and continuously recirculated through the reactor system with a variable speed pump. Because solar radiation contains a significant thermal component, it was necessary to control the fluid temperature by recirculation through a glass heat exchanger. Temperature and flow rate are continually mon-

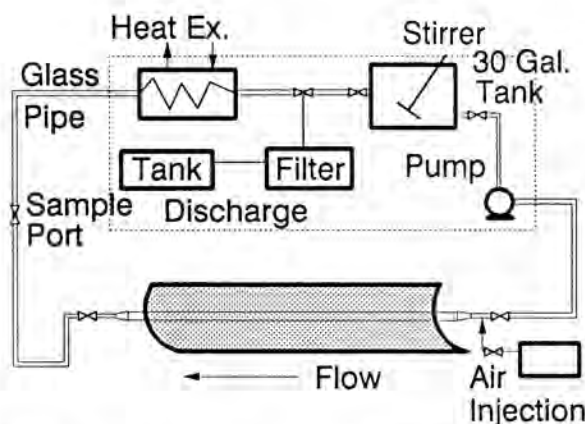

Fig. 2. Small outdoor trough system ( $3.5 \text{ m}^2$ ) depicting major components. The trough measures 0.76 m (30 in) by 4.9 m (16 ft) and concentrates sunlight about 20 times onto 38 mm (1.5 in) borosilicate pipe.

itored during operation of this system. All wetted parts of the apparatus were fabricated from materials that are chemically resistant to the organics under investigation.

### Engineering Scale Parabolic Trough

The purpose of this system is to extend work in the laboratory and small-scale trough to a scale approaching that of practical applications. Figure 3 is a schematic of this system. The engineering scale apparatus uses a series of six parabolic troughs with a 38 mm (1.5 in) I.D. diameter Pyrex borosilicate glass pipe mounted at the focus. The troughs have aluminized surfaces that reflect approximately 70% of the incident solar ultraviolet energy (300-400 nm) and concentrate the direct normal solar energy about fifty times. The system can be operated in either a batch or single pass mode at flow rates up to 25 gpm with two 1000 gallon tanks used for reservoirs of test solution and one 1000 gallon tank for holding clean water. The residence time for each pass was about 2.5 minutes at the highest flow rate. The total reactor length is 218 m (720 ft) and the total aperture area of the trough is 465 m<sup>2</sup>. Samples can be withdrawn at each 36.4-m (120 ft) section and from each tank.

### Materials

The TiO<sub>2</sub> photocatalyst (Degussa P-25, primarily anatase) had an average particle size of 30 nm and was used without further purification. The catalyst was suspended in water or immobilized onto various substrates. A fixed support eliminates the need to suspend, recover and filter the

catalyst from the water. Three types of catalyst supports were tested. Titanium dioxide supported on 3-mm silica glass beads was used in the bench scale solar simulator system. Alumina (Al<sub>2</sub>O<sub>3</sub>) frits coated with titanium dioxide, prepared by HiTech Ceramics, and fiber glass mesh with TiO<sub>2</sub> covalently bonded to its surface, prepared by Nulite Corporation, were tested on a bench scale under natural (total global horizontal) unconcentrated sunlight. All three systems were used to photodecompose trichloroethylene (TCE). Salicylic acid was also used in some experiments. All compounds, used without further purification, were diluted in deionized or tap water. Hydrogen peroxide was also used as an oxidant in some tests.

### Analysis

Analysis of trichloroethylene concentration was performed with a Hewlett-Packard Model-5890 gas chromatograph equipped with an automated headspace sampler (HP-19395A), tandem PID/ELCD detectors (IO Corporation), and a HP 530u series capillary column coated with an HP-1 crosslinked methyl silicone gum (30 m x 0.53 mm x 2.65 μm films). The TCE detection limit for this system is approximately 10 parts per billion (ppb) and analysis of standard aqueous TCE solutions was within 5% of the reference concentration. To verify TCE decomposition, chloride production was determined titrimetrically with HgNO<sub>3</sub> (Banco 0.0141 N) and diphenylthiocarbazone (HACH Chemical Corp.) as an indicator.

Samples with salicylic acid were analyzed with a Perkin Elmer UV-VIS spectrophotometer. The absorption peak of salicylic acid is 295 nm. The detection limit was about 1 ppm and the uncertainty of the measurements was +/- 3%. No analysis of the reaction products was conducted from salicylic acid decomposition.

## RESULTS AND DISCUSSION

Effect of Irradiation Intensity on Photocatalytic Decomposition of TCE No decomposition was observed unless both TiO<sub>2</sub> and light of band width 300-450 nm were present in the reactor. The effect of irradiation intensity, reported as relative intensity,  $I/I_0$ , on TCE decomposition is presented in Fig. 4.

$I_0$ , the maximum intensity without neutral density filters in place, is about 35 times the concentration of the UV component of nature sunlight (35 "suns"). The TCE concentration of a solution was reduced from 60 ppm to 5.4 ppm during 6.7 minutes of exposure with an irradiance approximately 31 times that of natural sunlight in the band 300-450 nm. The data plotted on a semi-log graph yield straight lines implying first-order kinetics. For long exposure times at the highest intensity, the reaction rate appeared to accelerate slightly. Table I lists the initial rate

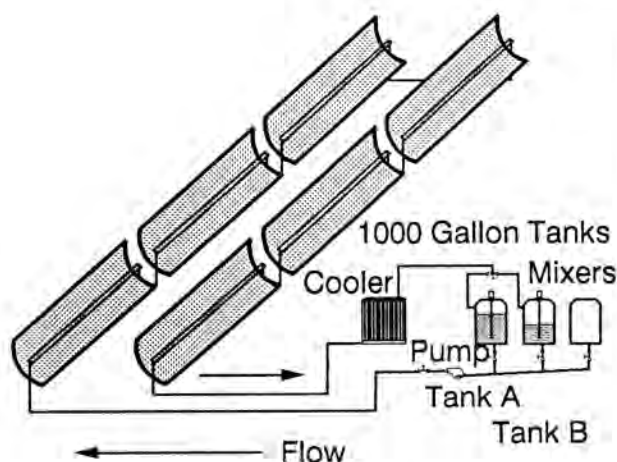

Fig. 3. Large outdoor trough system (365 m<sup>2</sup>) measuring 218 m long by 2.1 m wide with a 38 mm I.D. borosilicate glass pipe. The sunlight is concentrated about 50 with this trough. The flow rate was 100 liters/min (25 gallons/min).

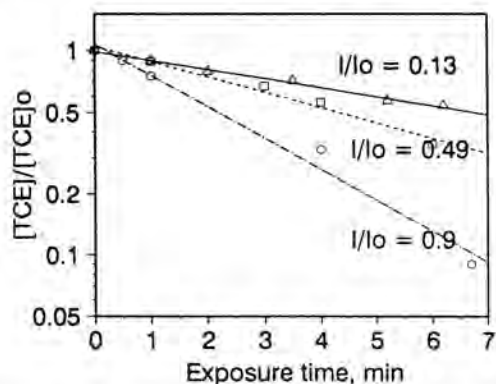

Fig. 4. Photocatalytic decomposition of trichloroethylene (TCE) with bench scale system, TCE concentration versus exposure time. 60 ppm initial TCE concentration, 0.1 wt% TiO<sub>2</sub> at 25 deg C.

constants,  $k$  (min)<sup>-1</sup>, obtained from the linear portions of Fig. 4.

Complete, rather than partial, decomposition of TCE was confirmed. Complete decomposition was concluded since: 1) the chloride ion concentration of the reacted solution agreed well with the total amount of TCE destroyed from the reaction. 2) chloride ions are stable and do not react appreciably in aqueous, oxygenated TiO<sub>2</sub> slurries (18), and 3) no other decomposition products were identified by GC/MS analysis of the solution. Therefore, CO<sub>2</sub> was concluded to be the other product of reaction.

TABLE I

Apparent first order rate constant  $k$  for TCE photocatalytic decomposition as a function of irradiation intensity. Conditions: 25 deg C and 0.1 wt% TiO<sub>2</sub>.

Irradiance I/I <sub>0</sub> (Suns)	[TCE] <sub>0</sub> ppm	Rate Constant, $k$ , min <sup>-1</sup>
0.90 (31)	60	-0.32
0.49 (17)	61	-0.16
0.13 (4.5)	60	-0.10

**Effect of Catalyst Loading on the Destruction of TCE with the Small and Large Trough Systems**

Amount of catalyst in suspension was varied to assess the effect on the destruction rate of TCE with both trough systems. Due to the high volatility of TCE in water, duplicate measurements of destruction rates were performed. Figure 5 compares TCE decomposition, as measured by GC headspace analysis, against results obtained by direct measurement of chloride ion concentration. The results indi-

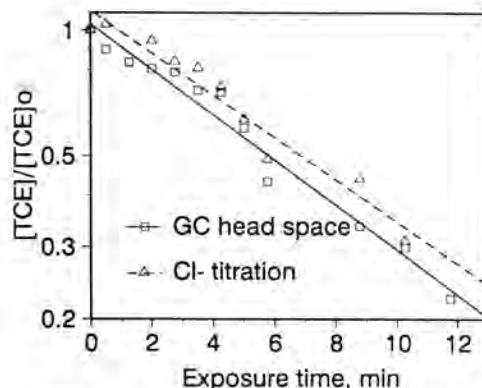

Fig. 5. TCE decomposition for the small trough system as measured by GC headspace analysis, against results obtained by measurement of chloride ion concentration.

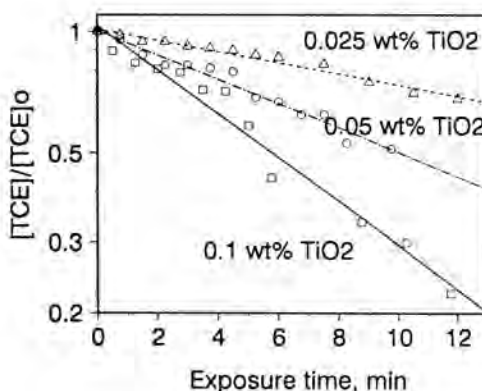

Fig. 6. TCE destruction at three different catalyst loadings with the small outdoor trough system. This system was operated in a recirculation mode.

cated good correspondence between both methods of measuring decomposition.

Figures 6 and 7 show the variation in TCE destruction rate with catalyst loading for the small and large trough systems. For each system, the experiments were conducted within +/- 1.5 hours of solar noon under sunny (high insolation) conditions. The initial concentration of TCE for each test was approximately 50 ppm with the small trough and 25 ppm for the large trough. The results indicate increased destruction rates with increased catalyst loading for both systems. The optimum catalyst loading for the large trough system, reported elsewhere (20), is approximately 0.1 wt% TiO<sub>2</sub>. This value for the optimal catalyst loading has also been observed in the lab scale reactor and seen in

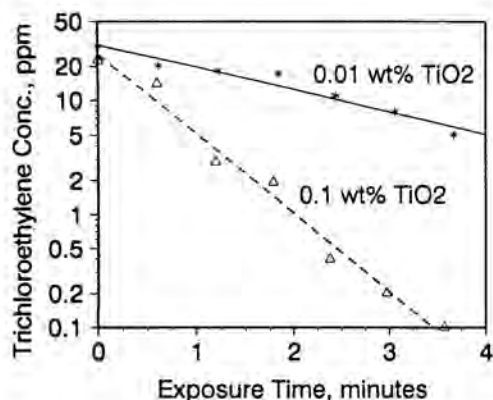

Fig. 7. Destruction of TCE in one pass from the large trough system at 0.01 and 0.1 wt% TiO<sub>2</sub>. The flow rate was 72 liters/min (19 gallons/min).

the literature (5,6). Chloride ion analyses of samples with the large trough system indicate at least 90% of the mass of TCE is accounted for which is a reasonable mass balance considering the size and complexity of the system and the experimental uncertainty of the measurements.

**Effect of Hydrogen Peroxide With Large Trough System**

Hydrogen peroxide is being considered as a possible enhancer to the process. The destruction of salicylic acid is shown in Fig. 8 for four different experiments conducted with the large 465 m<sup>2</sup> trough system. One run was done in the dark and the other three conducted with the trough in focus within +/- 1.5 hours of solar noon and a direct normal insolation (sunlight intensity) of > 950 W/m<sup>2</sup>. The time scale is expressed as exposure time, the amount of time the fluid is actually exposed to the light. These runs were conducted

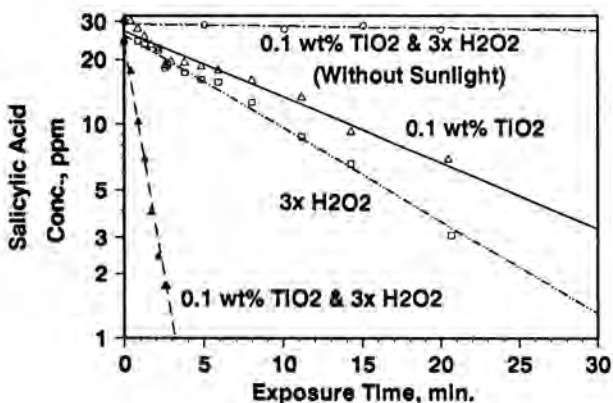

Fig. 8. Effect of hydrogen peroxide on the destruction of salicylic acid from the large trough system.

with similar initial salicylic acid concentrations and temperatures.

The lines through the data were obtained by log-linear regression. In the dark with TiO<sub>2</sub> and H<sub>2</sub>O<sub>2</sub>, there was insignificant change in the concentration of salicylic acid. With catalyst alone, destruction of salicylic acid to below 1 ppm required more than 45 minutes. With a hydrogen peroxide concentration of three times the stoichiometric amount (requirement for oxygen) and no TiO<sub>2</sub>, destruction to less than the detectable limit - 1 ppm - required about 33 minutes. With TiO<sub>2</sub> and three times the stoichiometric amount of H<sub>2</sub>O<sub>2</sub>, the reaction rate was about 8 times the rate with catalyst alone.

Similar results have been reported in the literature for trichloroethylene (19). The increased reaction rates may be attributed to a decrease in the electron hole recombination rate involving reaction of the hydrogen peroxide with conduction band electrons or by cleavage of hydrogen peroxide with superoxide ions to form hydroxyl radicals directly.

**Results From Supported Catalyst Experiments**

Silica beads were chosen as a support material because they are inert and transparent to UV and because TiO<sub>2</sub> slurries readily adhere to quartz and Pyrex surfaces. Decomposition rate constants, k, for TiO<sub>2</sub> supported on silica glass beads, are presented in Fig. 9 for consecutive runs with the bench scale system.

The rate constant, k, remained nearly constant for twelve consecutive runs for a total reaction time of 100 hours. The twelve consecutive batch experiments with the fixed bed exhibited strong, but less activity for TCE decomposition than a 0.1 wt% suspension of catalyst. Chloride ion accumulation rates agreed to +/- 18% with TCE decompo-

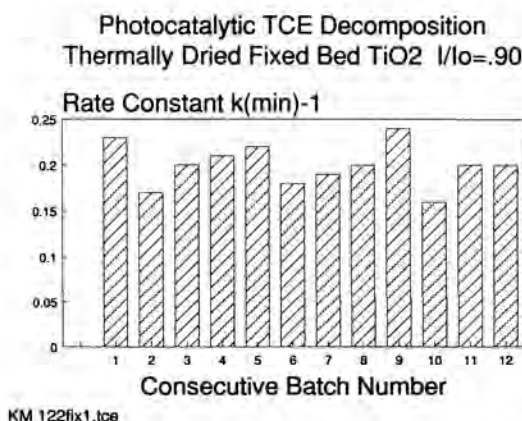

Fig. 9. Initial TCE decomposition rate constants, k, obtained with a fixed-bed TiO<sub>2</sub> catalyst (on glass beads) performed with the benchtop system. Reaction number if the number of consecutive batch reactions with the bed.

sition rates. Further investigation of the reacting surface with both surface sensitive and wet chemical techniques will yield information about changes in the TiO<sub>2</sub> surface conditions.

Two types of fixed catalyst samples were tested under one sun exposure (unconcentrated sunlight) to assess their performance and the effect of a variety of preparation conditions. Salicylic acid was used for these tests. The first support, prepared by HiTech Ceramics, consisted of Degussa titanium dioxide coated onto porous (10 pores per inch) alumina ceramic frits that have a structure similar to a rigid sponge. The frits were prepared under different conditions of firing temperature: 500, 750, or 1000 C, amounts of bonding agent (silicon dioxide): 0, 12.5, or 25%, and amounts of catalyst in the wash coat: 1 or 4 wt%. The second type of support was a fiberglass mesh, provided by Nulite Corporation, coated with Degussa titanium dioxide covalently bonded to the surface. Two different mesh sizes (A and C) were tested.

Figure 10 shows the percent decomposition of salicylic acid that occurred after one hour for each sample. A suspension of catalyst particles yielded the highest percent decomposition, possibly because the fine particles allowed excellent mass transfer and strong absorption of the ultraviolet light. Firing temperature had the greatest impact on the performance of the catalyst coated ceramic frits with the samples fired at 500 C showing the greatest activity. A possible reason that high temperature firing ( $T > 500$  C) deactivated the catalyst is that the anatase phase of TiO<sub>2</sub> is

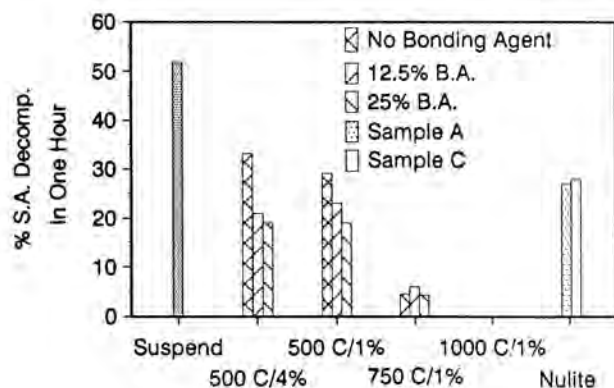

Fig. 10. Percent of salicylic acid decomposed in one hour under total global horizontal solar illumination (natural sunlight) for a suspension of TiO<sub>2</sub> for TiO<sub>2</sub> coated ceramic frits (prepared under different conditions) and for fiberglass meshes.)

converted to the rutile phase, which is known to be a less active photocatalyst (16).

Samples that did not contain bonding agent performed the best. The percent of catalyst in the wash coat had only a slight affect on the degradation, showing higher activities for the 4% wash coating. The Nulite samples performed about as well as the best ceramic frits, although some of the samples lost a slight amount of catalyst from the surface. The lower performance of the supported catalysts relative to a suspended catalyst may be attributed to mass transfer effects since the samples were only agitated and the fluid not actually pumped through the samples. Mass transfer rates can be enhanced significantly by pumping the fluid directly through the support.

## CONCLUSION

Preliminary results clearly demonstrate that increases in ultraviolet irradiation intensity increases TCE photocatalytic decomposition rates. Irradiance intensities up to 50 suns do not appear to adversely affect the kinetics of the process. The amount of catalyst in suspension affected the destruction rate of TCE with both the small and large trough systems. Hydrogen peroxide used in conjunction with TiO<sub>2</sub> enhanced the photocatalytic decomposition rate of salicylic acid by as much as 8 times the rates seen for only TiO<sub>2</sub>. Supported TiO<sub>2</sub> on silica glass beads yielded lower rates than a suspended TiO<sub>2</sub> for TCE decomposition under similar conditions. Alumina ceramic shows promise as a support for TiO<sub>2</sub> and demonstrated salicylic acid decomposition rates lower than a suspension when illuminated under natural sunlight and prepared at a firing temperature of 500 C without a bonding agent, SiO<sub>2</sub>. Samples prepared at higher temperatures and with the bonding agent appeared to be deactivated. TiO<sub>2</sub> on fiberglass mesh performed as well as the ceramic frits.

Many issues must be resolved before this process will be feasible for commercialization. Issues such as catalyst immobilization (eliminating the suspension and removal of the catalyst particles), catalyst deactivation and regeneration, catalyst enhancements, reactor design, the effect of minerals found in ground water, optimal residence times and thus flow rates, the control requirements for a solar detoxification system, and optimal solar concentrations must be addressed to assess their effectiveness on the process and its economics. Also, experiments with real contaminated water must be conducted to assess the performance of the process under real life conditions. Thorough analysis of the products will be necessary to understand the mechanisms of the overall process.

## ACKNOWLEDGMENTS

We acknowledge the following people for their contribution to this project: Lindsey Evans for his help in conduct-

ing the experiments and helpful suggestions on methodologies associated with the tests and making systems modifications and to Larry Yellowhorse for analyzing the salicylic acid samples, modifying and maintaining the trough system, and for his help in setting up the system for tests. We also thank the Nulite Corporation for donating samples of TiO<sub>2</sub> coated fiberglass mesh. This work is supported by the U.S. Department of Energy under contract DE-AC04-76DP00789.

#### REFERENCES:

1. Frank, S. N., Bard, A. J., "Heterogeneous Photocatalytic Oxidation of Cyanide and Sulfite in Aqueous Solutions at Semiconductor Powers," *J. Phys. Chem.*, Vol. 81, No. 15, 1977, pp. 1484-88.
2. Jaeger, C. D., Bard, A. J., "Spin Trapping and Electron Spin Resonance Detection of Radical Intermediates in the Photodecomposition of Water at TiO<sub>2</sub> Particulate Systems," *J. Phys. Chem.*, Vol. 83, No. 24, 1979, pp. 3146-3152.
3. Matthews, R. W., "Hydroxylation Reactions Induced by Near-ultraviolet Photolysis of Aqueous Titanium Dioxide Suspensions," *J. Chem. Soc. Faraday Trans. 1*, Vol. 80, 1984, pp. 457-471.
4. Barbeni, M., Pramauro, E., Pelizzetti, E., "Photochemical Degradation of Chlorinated Dioxins, Biphenyls Phenols and Benzene on Semiconductor Dispersions," *Chemosphere*, Vol. 15, No. 9, 1986, pp. 1913-1916.
5. Matthews, R. W., "Carbon Dioxide Formation from Organic Solutes in Aqueous Suspensions of Ultraviolet-Irradiated TiO<sub>2</sub>. Effects of Solute Concentration," *Aust. J. Chem.*, Vol. 40, 1987, pp. 667-75.
6. Ollis, D. F., "Contaminant Degradation in Water, Heterogeneous Photocatalysis Degrades Halogenated Hydrocarbon Contaminants," *Environmental Science and Technology*, Vol. 19, No. 6, 1985, pp. 480-484.
7. Matthews, R. W., "Photo-oxidation of Organic Material in Aqueous Suspensions of Titanium Dioxide," *Water Resources*, Vol. 20, No. 5, 1986, pp. 569-578.
8. Ahmed, S., Ollis, D., "Solar Assisted Catalytic Decomposition of the Chlorinated Hydrocarbons Trichloroethylene and Trichloromethane," *Solar Energy*, Vol. 32, No. 5, 1984, pp. 597-601.
9. Hsiao, C., Lee, C., Ollis, D., "Heterogeneous Photocatalysis: Degradation of Dilute Solutions of Dichloromethane, Chloroform, and Carbon Tetrachloride with Illuminated Titanium Dioxide Photocatalyst," *Journal of Catalyst*, Vol. 82, 1983, pp. 418-423.
10. Matthews, R. W., "Photocatalytic Oxidation of Chlorobenzene in Aqueous Suspensions of Titanium Dioxide," *Journal of Catalyst*, Vol. 97, 1986, pp. 565-568.
11. Al-Ekabi, Hussain, Serpone, Nick, "Kinetic Studies in Heterogeneous Photocatalysis. 1. Photocatalytic Degradation of Chlorinated Phenols in Aerated Aqueous Solutions Over TiO<sub>2</sub> Supported on a Glass Matrix," *Journal of Phys. Chem.*, Vol. 92, No. 20, 1988, pp. 5726-5731.
12. Yamagata, S., Nakabayashi, S., Sangier, K., Fujishima, A., "Photocatalytic Oxidation of Alcohols on TiO<sub>2</sub>," *The Chemical Society of Japan*, Vol. 61, No. 10, 1988, pp. 3429-3434.
13. Matthews, R. W., "Solar-Electric Water Purification Using Photocatalytic Oxidation With TiO<sub>2</sub> As A Stationary Phase," *Solar Energy*, Vol. 38, No. 6, 1987, pp. 405-413.
14. Borup, M. B., Middlebrooks, E. J., "Photocatalysed Oxidation of Toxic Organics," *Wat. Sci. Tech.*, Vol. 19, 1987, pp. 381-390.
15. Tyner, C. E., Pacheco, J. E., Haslund, C., Holmes, J. T., "Rapid Destruction of Organic Chemicals in Groundwater Using Sunlight," Hazardous Material Management Conference, Rosemont Illinois, March 1989.
16. Okamoto, K., Yamamoto, Y., Tanaka, H., Tanaka, M., "Heterogeneous Photocatalytic Decomposition of Phenol over TiO<sub>2</sub> Power," *Bull. Chem. Soc. Jpn.*, 58, 1985, pp. 2015-2022.
17. Pruden, A. L., Ollis, D. F., "Photoassisted Heterogeneous Catalysis: The Degradation of Trichloroethylene in Water," *J. Cat.*, Vol. 82, pp. 404-17.
18. Herrman, J. M., Pichat, P. J., "Heterogeneous Photocatalysis - Oxidation of Halide Ions by Oxygen in Ultraviolet Irradiated Suspensions of Titanium Dioxide," *Chem. Soc. Faraday Trans. 1*, Vol. 75, 1980, pp. 1138-46.
19. Tanaka, K., Hisanaga, T., Harada, K., "Photocatalytic Degradation of Organohalide Compounds in Semiconductor Suspension With Added Hydrogen Peroxide," *New J. Chem.*, Vol. 13, No. 1, 1989.
20. Pacheco, J. E., Tyner, C. E., "Enhancement of Processes for Solar Photocatalytic Detoxification of Water," 1990 ASME International Solar Energy Conference, Miami, FL, April 1990, *in press*.