

THE STARTING UP OF A PILOT PLANT FOR RADIOACTIVE INCINERATOR ASH CONDITIONING - RESULTS OF TWO EMBEDDING CAMPAIGNS

C.J. Kertesz - P.R. Chenavas - G.M. Naud
Département de Recherche et de Développement sur les Déchets
C.E.A Centre d'Etudes Nucléaires de Cadarache - France

ABSTRACT

A new pilot plant called "PICC" designed for radioactive incinerator ash conditioning, by embedding in several matrices, was launched at the Nuclear Research Centre in Cadarache - France - in the middle of 1988.

This polyvalent facility can work with the three following embedding products = cement, thermosetting epoxide resin and an epoxide-cement compound. The capacity per day of the plant is two 100 or 200 l drums of solidified ash form.

Two embedding campaigns have been carried out on inactive ashes : the first is a cementation campaign, done on phosphated ash coming from incineration of spent tributylphosphate. The second is a polymer cement campaign done on simulated alpha ash coming from technological wastes.

Description of the PICC and data on these two campaigns are given.

INTRODUCTION

The CEA supports several programs on radioactive incinerator ash conditioning. In the Cadarache Nuclear Center, the Département de Recherche et Développement Déchets develops chemical and technological processes devoted to the solidification of different types of incinerator ashes :

- α ashes ; their embedding is studied in 3 matrices : cement, epoxide thermosetting resin, and an epoxide-cement compound. This program is studied within the framework of a MOX fuel fabrication plant project.
- $\beta\gamma$ ashes, the embedding of which is studied in the 3 quoted matrices and in bitumen,
- incinerator ashes, stored in the CEN Cadarache facilities, coming from the treatment of spent organic liquids and also from treatment of radioactive technological wastes. Their embedding will be carried out in the polymer cement matrix,
- phosphated ashes, coming from the incineration of spent tributylphosphate, solidified in cement.

After laboratory scale studies [1], and in order to perform full scale tests, a polyvalent pilot plant, called PICC, able to work with 3 embedding binders, was put into service in mid 88.

The first embedding campaign was a cementation campaign of phosphated ashes. The second one was done on

inactive simulated alpha ashes, using the epoxide-cement matrix MOX ash solidification program.

A description of the PICC facility, and of the polyvalent process is given ; the results of the two campaigns and data on the different solidified ash forms are then presented.

THE "PICC" FACILITY

The PICC pilot plant is located in a technical building - which groups several other facilities, devoted to the waste chemical processing - where it occupies an area of 6 x 8 m. It is composed of a 7 m high tower including the process apparatus which is equipped with a confinement caisson, as a secondary barrier between the radioactive material and the other pilot plants in the working area.

The process apparatus is composed with the following elements :

- ash admittance glove box,
- vibrating sieve,
- storage and weighing tanks for liquid and for pulverulent components,
- high performance mixer,
- embedded ash form collecting device,
- connection elements.

At the 4 m level, an intermediate metallic floor is devoted to the feeding of the process with inactive pulverulent or liquid reagents.

At the 0-level, the control area is set up, with the control desk, the weighing system, and the auxiliaries such as the vacuum pump, temperature regulation device, hydraulic unit. The process can be operated in an automatized way, using a microprocessor. Moreover, at the same level a special area has been equipped for the intermediate storage of the solidified ash forms before hardening = it is installed in

a confinement caisson, located at the entrance of the PICC plant and contains a changing room for the operating personnel.

All the walls of the caissons are made of a fire resistant compound material = the different rooms are connected to the general ventilation building flow, which guarantees a depression gradient and an air renewing ratio, corresponding to the existing risks in the plant - Cf. Fig. 1 -

The Embedding Process - Description Of The Apparatus

The PICC facility is operated using a discontinuous process. The major component of the apparatus is a high performance mixer. The raw incinerator ash arrives in the facility, in 100 l metallic drums and then are discharged in a special glove box located at the top of the facility. All the products, either powders such as ashes, cement, or liquids such as water or thermosetting resins are stored in tanks working underload, i.e they come to the mixer, at the lower part of the facility, by the means of gravity. After mixing of all the components, the embedded ashes are received in a 100 or 200 l metallic drum. Cf. Fig. 2.

The Mixer

This device is a high performance mixer - GUEDU trademark, France - made of 304 L stainless steel, with a 175 l cylindric double wall vessel, containing a rotating scraping paddle. At the lower part of the vessel wall, a vertical door, hydraulically operated allows for the ejection of the paste.

The mixer lid, with a spheric portion shape is fitted with flanges and tubes, for connection to the process flow, such as :

- liquid reagent feed,
- pulverulent feed,
- observation window and light,
- high pressure washing device,
- ventilation and vacuum connections, including filters.

This apparatus can work under regulated temperature (10 to 50°C) and pressure (10^4 Pa). Cf. Fig. 3.

The Collecting Chamber of the Final Product

This chamber has been designed to work under reduced pressure, like the mixer, allowing to receive an embedded ash paste without any air bubble. It is fitted with a front door and a rolling track for admission and delivery of the drum. Moreover, safety devices give indications on

drum position in the chamber and filling of the drum during the discharge of the mixer.

Pulverulent Feeding Flow

• Ash Admittance (inlet) Glove Box

At the upper part of the apparatus is a stainless steel glove box, fitted with a dumping device - CEA patent - allowing for the connection of a 100 l metallic drum to the glove box inlet : the lid connects itself to the pivoting door, by the means of a pneumatic suction device. The ash transfer tightness is guaranteed by inflation of a rubber inner-tube surrounding the circumference of the drum - moreover, the downward angle of the dumper allows for complete emptying of the drum and receipt of ashes on the glove box floor having the form of a funnel, leading into the following process apparatus.

• Vibrating Sieve

Designed to separate the ashes from the solid particles, a high capacity vibrating sieve is placed below the glove box. The sieve mesh is 2 m/m ; the sieving oversize is sent to the solid waste cementation conditioning, and the ashes go to the intermediate storage tank.

• Intermediate Storage Tank

A 850 l cylindric vessel, is connected to the sieve : it is fitted with a paddle, feeding a distributor screw. For nuclear safety, a detection equipment for low level of ash is placed at the bottom and a connection to the ventilation circuit keeps the tank under negative pressure.

• Cement Tank

The cement is fed to the process, in a 100 l hopper, made of ordinary steel : at the upper part of the hopper, the inlet is connected to a plexiglass box, where 50 kg cement trade bags are opened.

• Tank For Pulverulent Weighing And Premixing

This horizontal 4 m³ steel tank is vacuum tested - work vacuum 10^4 Pa - It is fitted with an "8" shaped rotating paddle, designed for the cement and ash premixing. Moreover, in this vessel pulverulent products are weighed. The weighing function implementation is done by 4 balances working with torsion gauges - The weighing data, managed by a microprocessor, are sent to the control desk.

Liquid Reagents Feed

On the same intermediate floor 3 100 l tanks are placed for the liquid reagents feeding such as epoxide resin, hardener. Each tank is placed on a weighing system, similar to

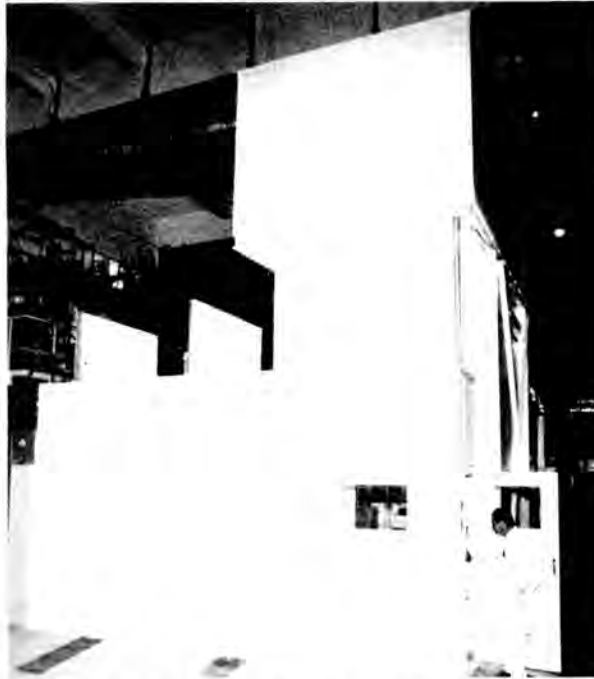

Fig. 1. The PICC Facility-General Outside View.

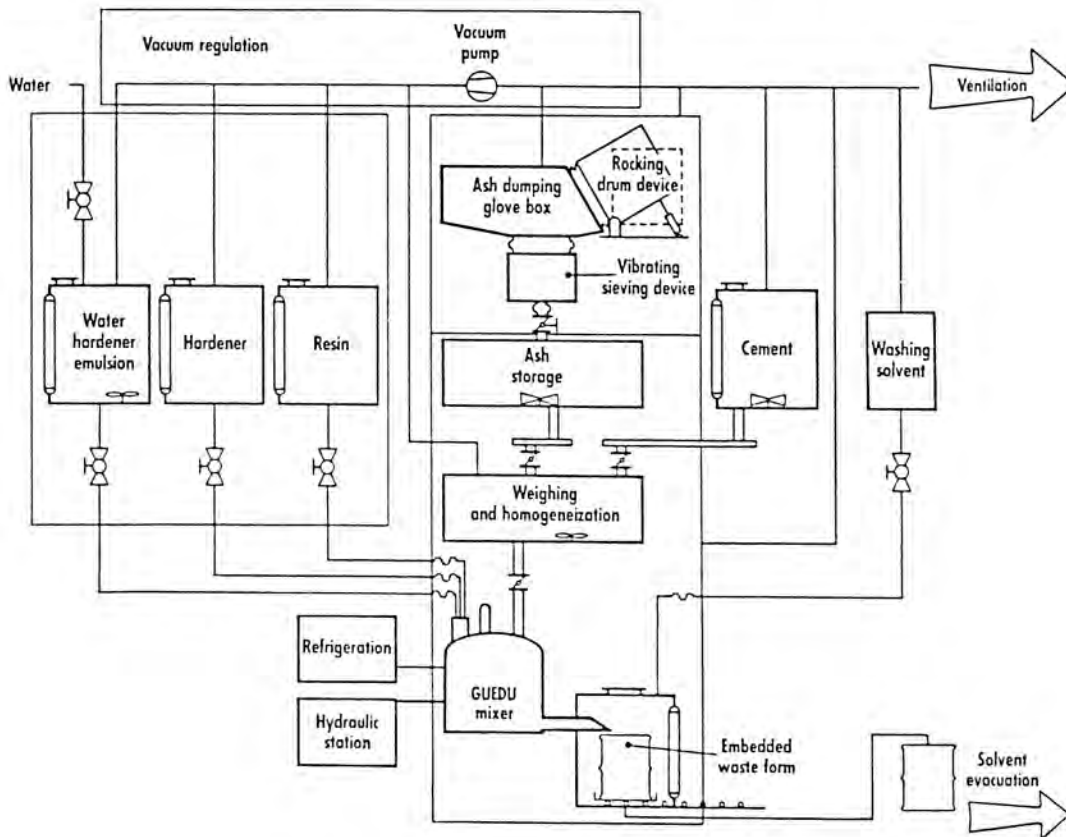

Fig. 2. PICC- Incinerator ash conditioning facility.

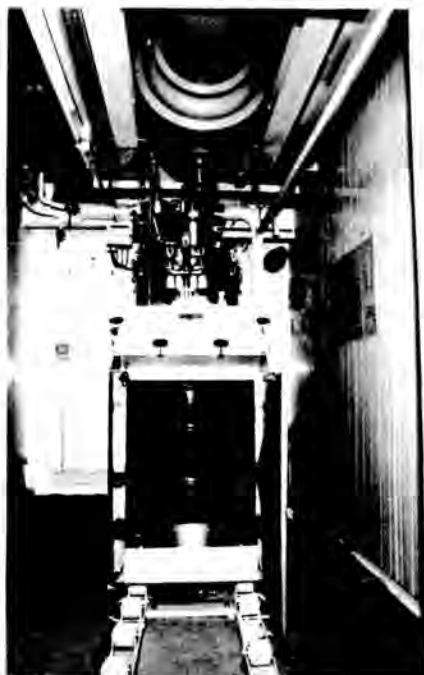

Fig. 3. PICC-View of the Apparatus.

the previous and connected to the vacuum pump for air degassing.

Auxiliaries

- **Production Of Cold**

It is carried out by a 6 kW refrigerator unit - with 3 independent heat exchange flows. In case of necessity the mixer is refrigerated by a coolant liquid flow, having no contact with the freon of the refrigerator unit. This device allows to work with a regulated temperature from - 10°C to 60°C.

- **The Vacuum Pump**

A vane pump - ALCA TEL trade mark, France - 170 m³ flow rate, guarantees a vacuum limit of 5.10⁻¹ mbar in the process apparatus. This vacuum pump inlet is connected to the mixer, to the premixing tank and the other elements of the process, through the filtration system : the outlet goes to the ventilation flow.

- **The Ventilation Circuit**

The PICC pilot plant is connected to the general ventilation circuit of the building. The plant needs a 1800 m³.h⁻¹ extraction flow rate, allowing a negative pressure of - 5 m/m water column, in the confinement caissons and a value of - 30 mm water column in the process apparatus, especially in the ash admittance

glove box. Renewing air ratio values are equal to 2-3 in the confined areas and 10 in the process apparatus.

THE EMBEDDING PROCESS - RESULTS OF TWO EXPERIMENTAL CAMPAIGNS

The Embedding Binders

The polyvalent design of the PICC pilot plant allows to change the embedding matrix, in the process and to therefore produce three different embedded ash forms. The three following binders are used :

- the cement, with a water/cement ratio ~ 0,6 or 0,7. The cement is used as a ternary cement containing ordinary Portland cement 60 %, blast furnace slag 20 % and flying ashes 20 % - French appellation CLC45 - It can be used also as a binary compound with CPA 60 % and blast furnace slag 40 %
 - French appellation CLK45 - The embedded ratio depending on the ash composition and the type of cement is 20 to 30 %.
 - The thermosetting epoxide resin matrix, used as a two component system, with a fluid resin and a hardener. The products chosen must possess several properties = low viscosity, poor polymerization exotherm. Two types of epoxide products are used :
 - the CIBA GEIGY products with XF431 resin and XF348 hardener,
 - the CDF chimie products with MN201 resin and D2000 hardener. The embedding ratio reaches 40 % or more.
 - The cement-epoxide matrix : this product is composed of a water cement paste (w/c = 0,3-0,4) - 1 part - mixed with a two component epoxide system - 1 part. The cement which is used is the CLC cement, and the polymer component is the CDF chimie product. Using this mixed matrix, the embedding ratio is 40 %.
- Implementation Of The Embedding Process
- Implementation of the embedding process is described in the diagram presented in Fig. 4.

Cementation Campaign of Phosphated Ashes

The object of this campaign was the transposition at the industrial scale, of a formulation, resulting of a laboratory work : the campaign has been carried out on inactive ashes, coming from the incineration of tributylphosphate. It of raw ashes have been solidified, giving ten 100 l drum and two 200 l drum packagings. The operating conditions of the cemented ash form fabrication have been checked and also, different measurements and tests have been practiced on

samples taken on the paste, during and after complete mixing. These measurements are the following :

- viscosity of the paste versus time, for different mixing conditions,
- water sweating ratio - settling ratio of the paste,
- mechanical properties measurements, after hardening,
- on full packagings, cutting and observation of the homogeneity.

Ash Composition

The phosphated ashes are mainly composed of calcium pyrophosphate - $\text{Ca}_2\text{P}_2\text{O}_7$, in which calcium amount is equal to 31.5 % and phosphorus amount is 24.4 %, with a molar ratio $\text{Ca/P} = 1$ - Calcium and Phosphorus analysis, made on ash, give :

$$\text{Ca} = 30 \% - \text{P} = 25 \% \text{ with } \text{Ca/P} = 0.94$$

The granulometry measurement has been done : 90 % of the ash diameter is measured between 1,3 μm and 60 μm . Moreover, the specific weight is 0,8 to 1 g.cm^{-3} .

Solidification Formulation

The formulation uses a cement, with a high content of blast furnace slag - CLK 45. With this cement matrix, the ash embedding ratio is 30 %.

Operating Conditions

Data are given in the Table I, which is divided in 2 parts corresponding to different conditions :

- from packaging No. I-1 to No. I-5 : the feeding of reagents is the following : 1-liquids, including water and fluidizing agent 2-ashes 3-cement,
- from the II-1 embedded form till the last one, we have introduced a variation in the operating method = after feeding the liquids, ash and cement are premixed in the premixing tank and then fed into the mixer for preparation of the embedded product.

Results Of The Measurements

Results of sweating, settling, viscosity and compression strength, hardening temperature are given in Table II.

Commentaries can be done : the quality of embedded form obtained, without or with premixing is not very different.

Packagings of the second series show values of the mechanical strength measurements 15 % higher.

Homogeneity

Premixing and use of the vacuum during the mixing

operation, eliminates bubbles of air, giving a denser aspect to the final product, as shown by the comparison between the II-6 and II-7 packagings. Cf. Fig. 5.

Typical Crack Of The Embedded Form

Corresponding to a poor mixing condition - low speed of the paddle some embedded ash form show a typical crack on the top - Cf. Fig. 6. The shape of this crack seems to come from thermal constraint, being higher than the mechanical resistance of the product.

POLYMER CEMENT EMBEDDING CAMPAIGN OF SIMULATED ALPHA ASHES [2]

In this campaign, ash was used coming from the treatment of solid inactive burnable waste of the Nuclear Research Centre in Cadarache. The initial waste composition is quite comparable to that of wastes coming from a nuclear fuel fabrication plant. The main components are constituted with cellulose, polyvinylchloride, polyethylene, rubber, etc... consequently the ash composition of these two kind of wastes is near each other. Cf. Table III.

Formulation

The applied epoxide cement formulation has been described [1], it can be expressed in weight percent :

- incinerator ashes 40 % - cement and water (W/C = 0.36) 30 % - epoxide-hardener 30 %.

For these full scale tests on simulated γ ashes, the epoxide cement matrix was tested = indeed, data gained from laboratory scale samples of epoxide cement ash form, containing a high activity of ^{238}Pu have shown interesting characteristics, such as : [4] :

- high ash embedding ratio,
- high compression resistance,
- good leaching test behavior,
- acceptable hydrogen radiolytic flow - $G(\text{H}_2) = 0,1$.
- Objectives Of The Campaign - Results

The objectives of this campaign were :

- to transpose a formulation coming from a laboratory work to full scale packagings, and to optimize the fabrication conditions of the embedded product,
- to check the characteristics of the solidified ash form obtained using two different epoxide systems,
- to carry out efficiently the cleaning of the mixing apparatus.

Results

The operating route for fabrication of embedded poly-

TABLE I
Phosphated Ash Cementation Campaign-Operating Conditions

	I					II						
N° of the packaging	1	2	3	4	5	1	2	3	4	5	6	7
Nature of the process	No pulverulent premixing					Pulverulent premixing						
Pressure	AP	AP	AP	AP	V	AP	AP	AP	AP	V	V	AP
Volume (liters)	80	80	80	80	80	80	80	80	80	80	160	160
Mixing rate t.mn ⁻¹	30 to 60	40	60	80	40	30 to 60	40	60	80	80	60	60
Specific weight	1.89	1.97	1.94	2	1.99	1.97	1.99	1.99	2.01	2	1.88	1.89

AP = Atmospheric pressure - V = under vacuum

TABLE II
Phosphated Ash Cementation Campaign-Results of the Tests.

N° of the packaging	I-1	I-2	I-3	I-4	I-5	II-1	II-2	II-3	II-4	II-5	II-6	II-7
Water sweating in - %	-	2.3	3	2.3	2.6	-	2.5	2	3.3	3		
Settling of the paste %	-	0.4	0	0.4	0.4	-	1.7	1	1.7	< 1	-	-
Compression strength - MPa -	-	30	28	30	28	-	35	34	30	28	27	-
Viscosity mN m ⁻¹ -	-	1.6	2	1.8	2	1	1	1	1	1	1	1
Hardening temperature -°C-	-	60°C			55°C	65°C					66°C	72°C
Time -hours-	-	50			44	40					30	33

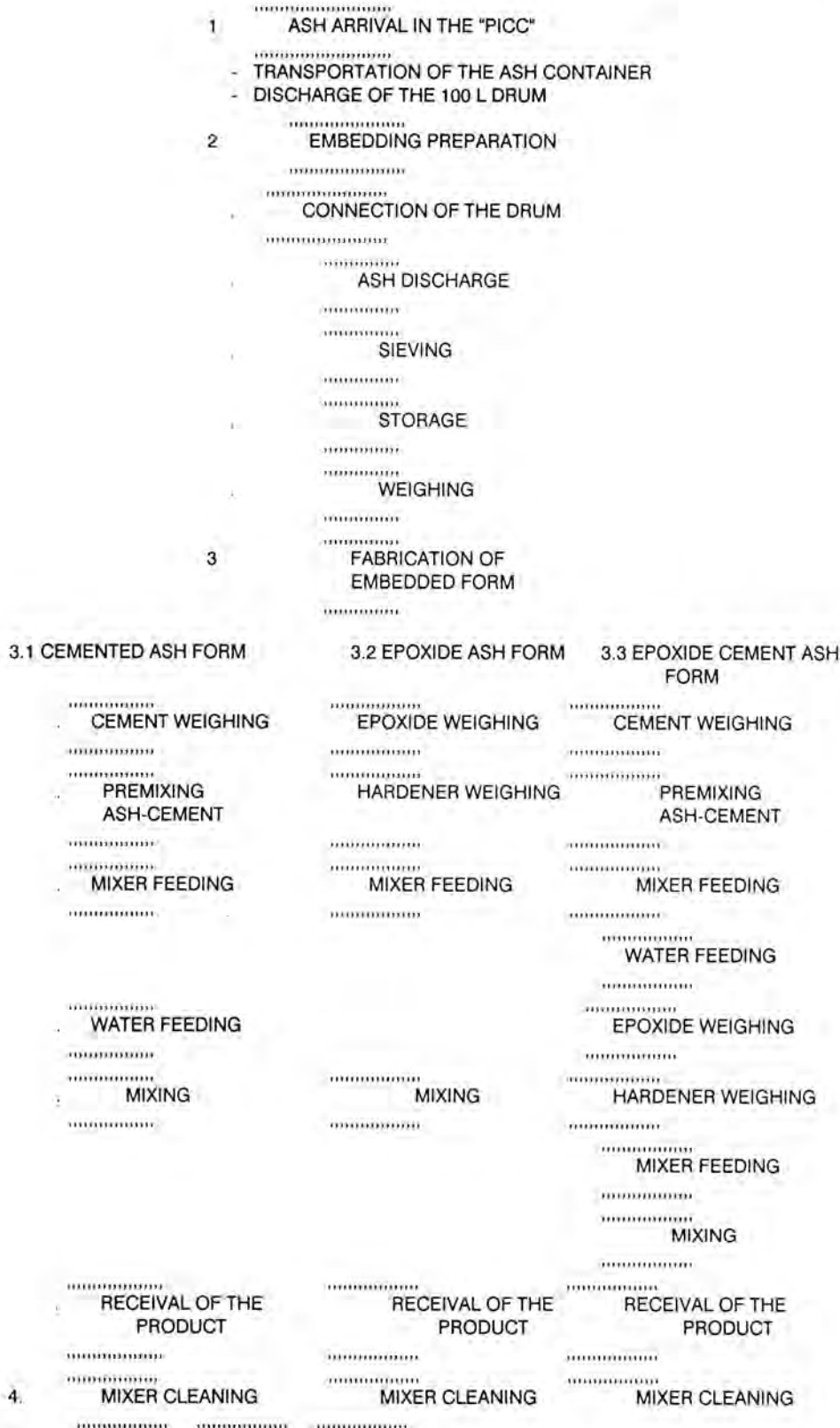

Fig. 4. The PICC Polyvalent Embedding Process Chart.

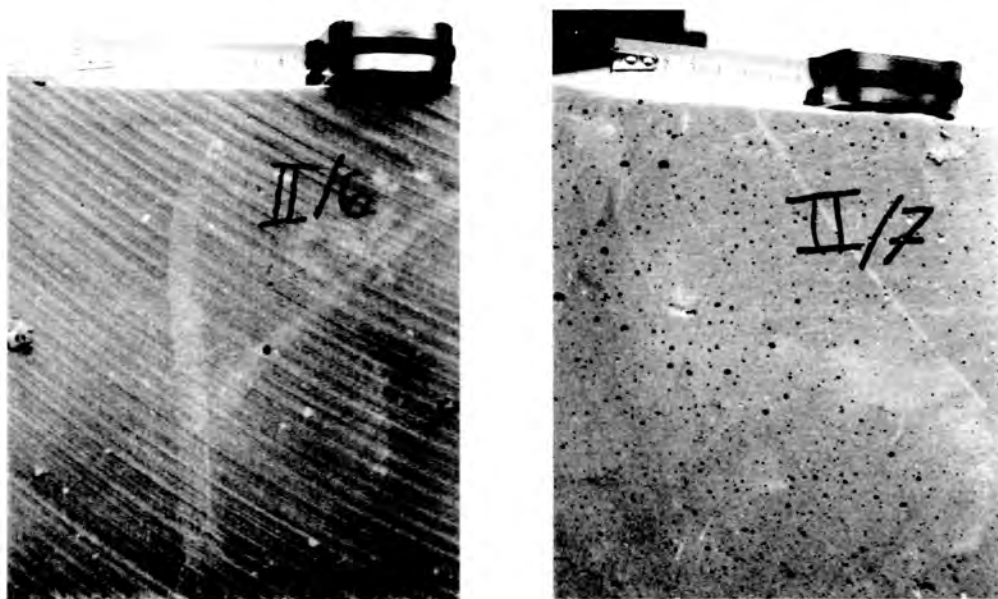

Fig. 5. Cemented Phosphated Ashes-Quality of the Product After Degassing.

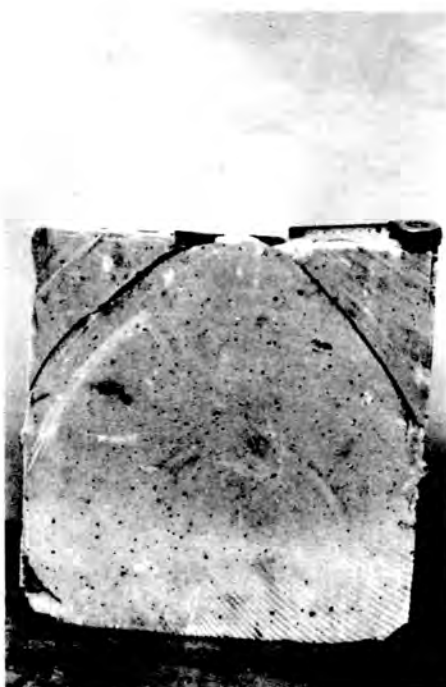

Fig. 6. Cemented Phosphated Ashes-Typical Crack.

etc... consequently the ash composition of these two kind of wastes is near each other. Cf. Table III.

Formulation

The applied epoxide cement formulation has been described [1], it can be expressed in weight percent :

- incinerator ashes 40 % - cement and water (W/C = 0.36) 30 % - epoxide-hardener 30 %.

For these full scale tests on simulated y ashes, the epoxide cement matrix was tested = indeed, data gained from laboratory scale samples of epoxide cement ash form, containing a high activity of 238 Pu have shown interesting characteristics, such as : [4] :

- high ash embedding ratio,
 - high compression resistance,
 - good leaching test behavior,
 - acceptable hydrogen radiolytic flow - $G(H_2) = 0,1$.
- Objectives Of The Campaign - Results

The objectives of this campaign were :

- to transpose a formulation coming from a laboratory work to full scale packagings, and

to optimize the fabrication conditions of the embedded product,

- to check the characteristics of the solidified ash form obtained using two different epoxide systems,
- to carry out efficiently the cleaning of the mixing apparatus.

Results

The operating route for fabrication of embedded polymer cement ash form has been investigated, changing the order of the reagent introduction in the mixer and checking properties of the final product. Two different epoxide system i.e. epoxide resin and hardener mixtures, were tested : the LOPOX epoxide system CDF chimie - and the INJEPOX epoxide system - LASSAILLY trade mark. The results of feasibility measurements are shown on the Table IV. Moreover important data are obtained from the polymerization temperature curve VS time -Cf. Fig. 7-8.

It can be noticed for LOPOX products, polymerization temperature data are different according to the reagent admittance order. Good results (low paste viscosity, poor

TABLE III
Composition in Percentage of Two Types of Ashes Coming From Technological Wastes.

Nature of ash	%															
	Si	Ca	Al	Fe	Ti	Zn	Mg	Cr	Sn	Ni	Mo	P	Mn	Na	Cl	C
Inactive ash (Cadache N.C.)	25	6,5	12	20	3	0,7	0,4	0,01	0,05	0,005	0,005	0,1	0,004	1,2	1,3	7
Technological waste Incinerator ash (Marcouffe plant)	13 -20	7 -9	7 -12	11	3,3	4	0,1 -1,5	1,4	0,5	3		1	0,3	0,3		0,1

TABLE IV
Epoxide-Cement Campaign-Comparative Tests Using Two Different Epoxide Systems.

N° of the packaging	Reagent admittance order	Addition of water - L -	Maximum of Electric intensity - A -	Sweating of water - L -	Quality of the poste	Compression strength - MPa -	Epoxide System
1	W+H+A+Ce+Ep	5	8.6	0	- Thick	-	-
2	W+H+Ep+A+Ce	5	-	0	- Good	-	INJEPOX
3	W+A+Ce+Ep+H	7	-	0	- Thick	-	-
4	A+Ce+W+Ep+H	3	8.15	0	- Fluid	-	-
5	W+H+A+Ce+Ep	5	8.9	3	- Fluid	36	-
6	W+Ep+A+Ce+H	3	6.5	0	- Fluid	43	-
7	W+Ep+H+A+Ce	3	6.6	0	- Thick	49	LOPOX
8	W+f+A+Ce+Ep+H	1	7.2	0	- Medium	60	(CDF chimie)

Legend : A = Ash Ce = Cement W = Water Ep = Epoxide resin H = Hardener f = Fluidizing agent

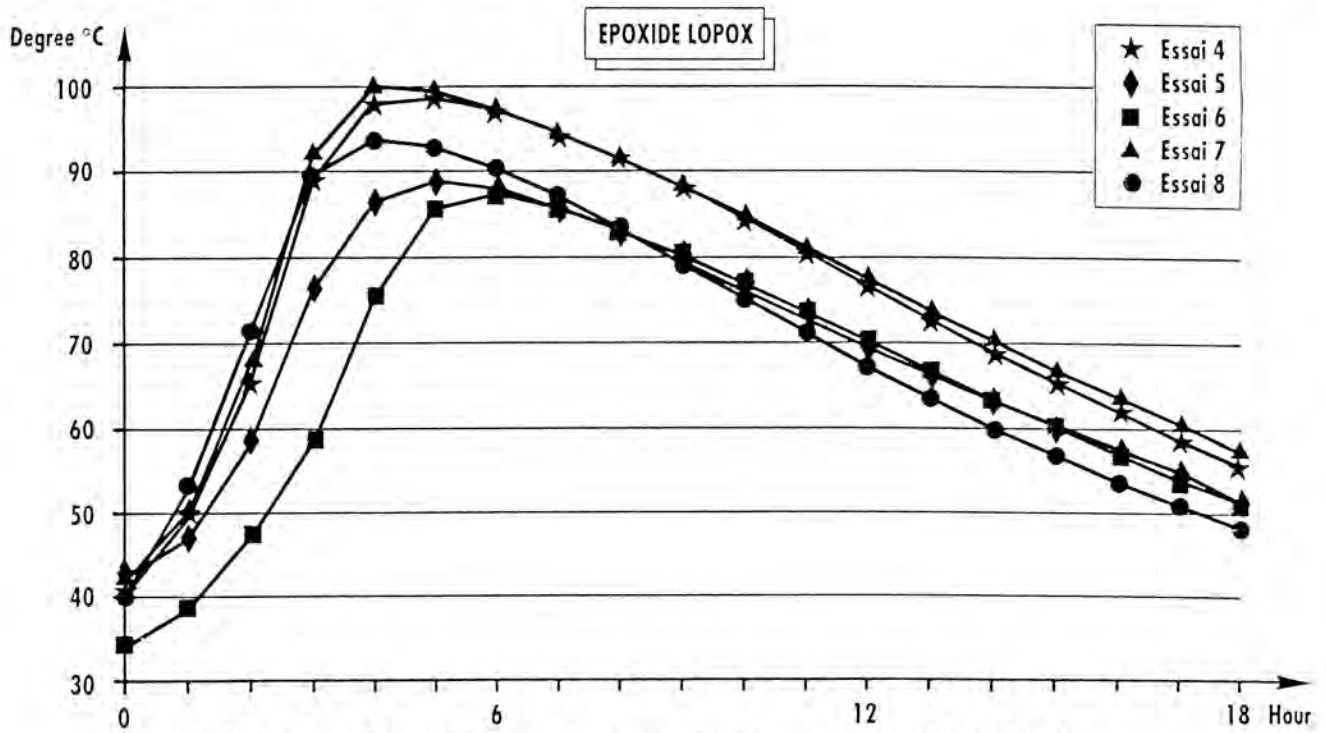

Fig. 7. Epoxide Cement Campaign-Polymerization Temperature LOPOX Epoxide.

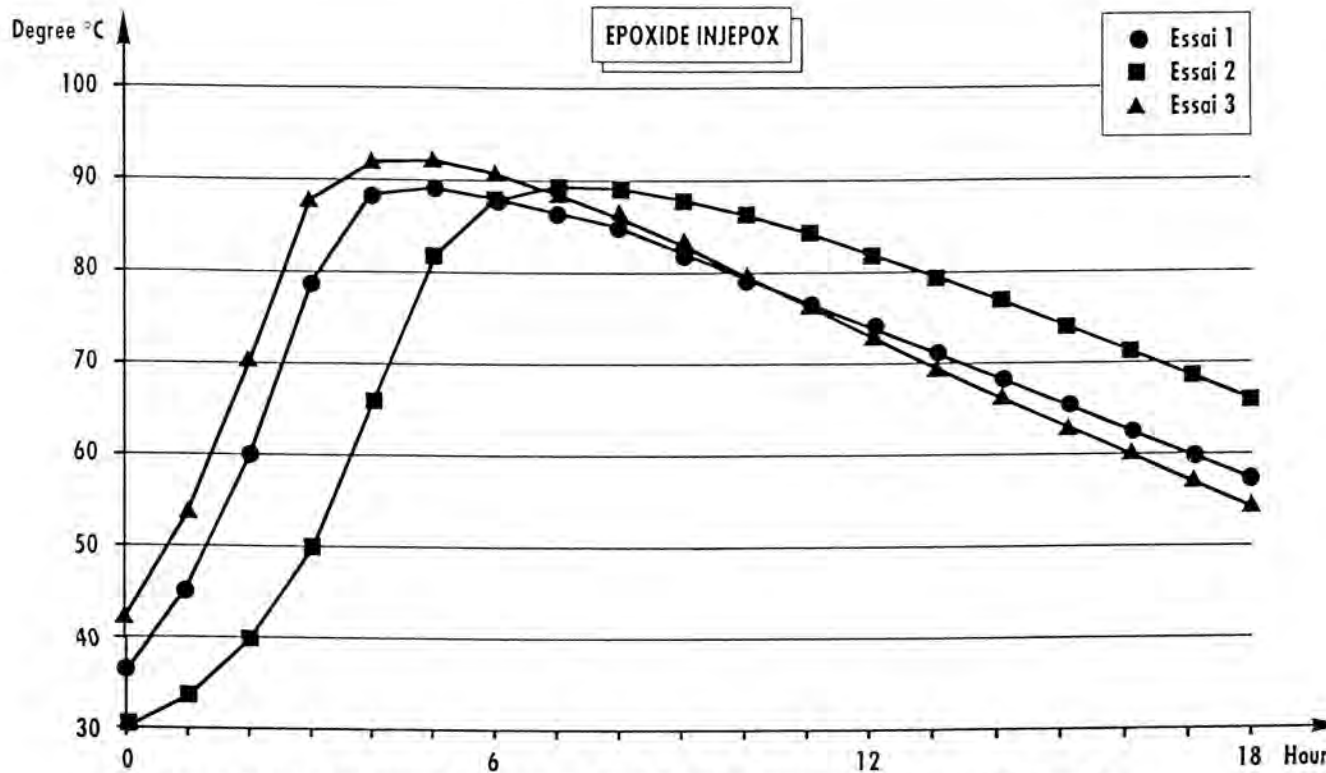

Fig. 8. Epoxide Cement Campaign-Polymerization Temperature-INJEPOX Epoxide.

exotherm value) are obtained when liquids are admitted at first, i.e. before that of pulverulent compounds.

- Initial temperature of the reagents interferes on that of the final product and on the polymerization peak.
- With INJEPOX products, if the exotherm temperature is acceptable, on the other hand, the viscosity of the paste, obtained after mixing, is too high. The formulation requires to be adjusted.

Cleaning Of The Apparatus

To be qualified at the industrial scale, the epoxide cement embedding process includes a step of apparatus cleaning. Two directions have been studied :

- use of an appropriate cleaning solvent,
- operation with a high pressure cleaning device.

Good results were obtained using a specific epoxide resin diluent, chemical formula of which is hexanediol diglycidylether = this product possesses the interesting property to give the possibility of being mixed with pure epoxide and reprocessed in the fabrication of a new polymer cement ash form. Moreover methylethylketone and also TBP/dodecane mixture can be used as finishing cleaning solvent.

For these cleaning operations, a special cleaning device is actually being installed on the mixer lid. It consists of a 3 axis movable device, with a rotating head, equipped with high pressure nozzles, sprinkling liquid inside the mixer vessel. The operating pressure reaches 200 bar - Barthod trade mark, France -

CONCLUSION

During the two first campaigns carried out on the PICC facility, twelve cemented phosphated ash form conditioned in 100 and 200 l metallic drums and a ten of polymer cement technological waste ash form in 100 l drums were produced.

The operations to change of embedding matrix were clearly designed and were absolutely simple. All the technological options were qualified and checked, except the automatized way, using the microprocessor to operate the embedding process.

The cementation campaign made on phosphated ash, allowed the pulverulent premixing to be qualified = also

the homogeneity of the embedded product is improved by working under reduced pressure. Poor mixing conditions have shown the unknown phenomenon of the Typical crack of the solidified cemented phosphated ash form.

In the second campaign, the polymer cement process was carried out on solid waste incinerator ash : optimization has been done in choosing the best reagent admittance order before mixing. The properties of two epoxide systems, were checked. The LOPOX epoxide products work better than INJEPOX . After fabrication, cleaning of the mixer is easily feasible, using phenyldiglycidylether, and MEK or TBP/dodecane as finishing solvent. Moreover, using a high pressure cleaning device will provide a perfect washing of the apparatus, in spite of the adhesive quality of the epoxide cement matrix.

As a good R-D apparatus the PICC facility will continue to work especially on the MOX fuel plant incinerator ash conditioning program. In the future, the pilot plant will work on active products and will be used to solidify the real active ashes, produced by the two Cadarache incineration plants and stored temporarily before their conditioning.

Part of the embedding technique was performed and funded within the framework of the European Communities research programme on Management and Disposal of Radioactive Waste.

REFERENCES

1. C. KERTESZ, C. COURTOIS Conditionnement des cendres des incinérateurs du CEN Cadarache - IAEA - SM - 303/81 - International symposium IAEA-CEC Stockholm 16-20 may 1988.
2. C. KERTESZ, R. RICCUCCI, L. AUFRET Etude du conditionnement des cendres alpha et béta-gamma produites par incinération de déchets radioactifs dans différentes matrices. C.E.C Research contract FI-1-W0005F - Progress report No. 5.