

CONSTRUCTION FEATURES OF THE EXPLORATORY SHAFT AT YUCCA MOUNTAIN

G. W. Adair, Reynolds Electrical & Engineering Co., Inc.
J. N. Fiore, U.S. Department of Energy

ABSTRACT

The Exploratory Shaft (ES) at Yucca Mountain is planned to be constructed during 1985 and 1986 as part of the detailed site characterization for one of three sites which may be selected as candidates for location of a high-level radioactive waste repository. Conventional mining methods will be used for the shaft sinking phase of the ES project.

The ES will be comprised of surface support facilities, a 1,480-foot-deep circular shaft lined with concrete to a finished inside diameter of 12 feet, lateral excavations and test installations extending up to 200 feet from the shaft, and long lateral borings extending up to 2,300 feet from the shaft. The estimated time for sinking the shaft to a total depth of about 1,480 feet and completing the lateral excavations and borings is about two years.

The major underground development planned for the primary test level at a depth of 1,200 feet consists of the equivalent of 1,150 feet of 15- by 15-foot drift. The total volume of rock to be removed from the shaft proper and the lateral excavations totals about 1/2 million cubic feet.

Construction equipment for the shaft and underground excavation phases consists of conventional mine hoisting equipment, shot hole and rock bolt drilling jumbos, mucking machines, and hauling machines. The desire to maintain relatively uniform and even walls in selected shaft and drift intervals will require that controlled blasting techniques be employed. Such techniques generally classified as "smooth blasting" are commonly used for excavation in the construction industry.

Certain lateral boring operations associated with tests to be conducted in the underground development may pose some unusual problems or require specialized equipment. One of the operations is boring and lining a 30-inch-diameter by 600-foot-long horizontal hole with a boring machine being developed under the direction of Sandia National Laboratories. Another special operation is coring long lateral holes (500 to 2,000 feet) with minimum use of liquid circulating fluids.

INTRODUCTION

The statutory process for siting an underground repository for the disposal of high-level radioactive waste requires that site characterization activities be conducted by the U.S. Department of Energy at candidate repository sites to evaluate the suitability of such sites for construction of a repository. The site characterization activities include "... excavations of exploratory shafts, limited subsurface lateral excavations and borings; and in situ testing" ¹ All of the above-mentioned activities are included in the Exploratory Shaft (ES) at Yucca Mountain project. The emphasis in this discussion will be on the excavation of the shaft and associated subsurface lateral excavations and borings. A comprehensive discussion of the in situ testing activities is contained in the Test Plan for the Exploratory Shaft at Yucca Mountain being developed by the four scientific organizations identified below.

The ES at Yucca Mountain project is managed by the Waste Management Project Office, U.S. Department of Energy, Nevada Operations Office. Scientific services for the project are provided by the Los Alamos, Lawrence Livermore, and Sandia National Laboratories and the U.S. Geological Survey. Technical and management support services are provided by Science Applications, Inc. Engineering services are provided by Fenix and Scisson, Inc., for drilling and mining, and Holmes and Narver, Inc., for surface facilities. Construction, operations, and maintenance services are provided by the Reynolds Electrical and Engineering Co., Inc. (REECO).

The Yucca Mountain Site (see Figure 1), approximately 90 road miles from Las Vegas, Nevada, near the southwest corner of the Nevada Test Site (NTS), is considered to be a potentially acceptable site for a geologic repository. Excavation of the ES is scheduled to begin during the late summer of 1985 pending recommendation of the site by the U.S. Department of Energy and approval of that recommendation by the President in the first quarter of calendar year 1985.

¹National Waste Policy Act of 1982, Section 2, Paragraph (21)B.

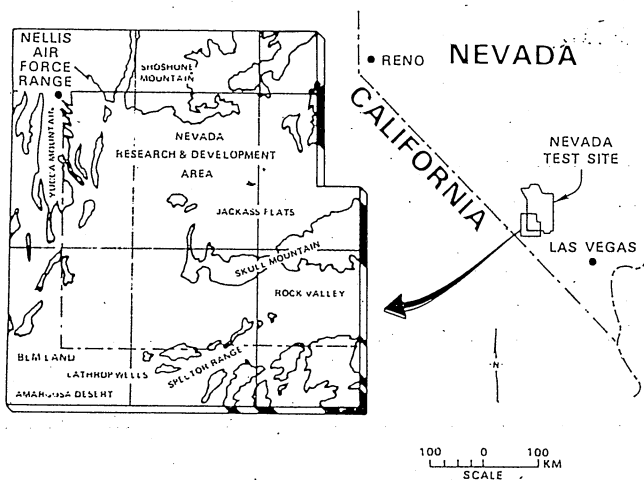

Figure 1. General Location Map

EXPECTED SUBSURFACE CONDITIONS

The underground strata of interest at Yucca Mountain is a sequence of volcanic ash beds which, for the purposes of this discussion, are considered to be included under the overall geologic term of tuff. A confirmatory geologic hole located about 260 feet from the ES surface location was cored to a depth of 3,000 feet. A geologic section developed from that core hole data and other information are shown in Figure 2.

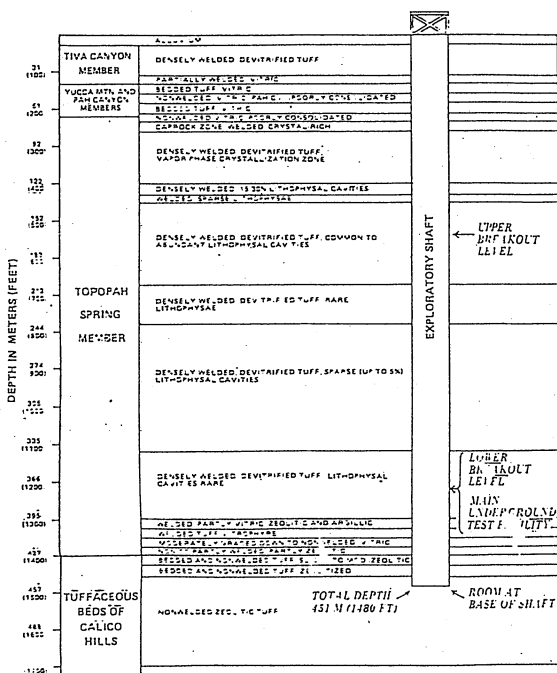

Figure 2. Geologic Section at ES Site (Ref. 1)

The sequence of tuffaceous beds at the ES site is overlain by about 40 feet of alluvial fill. The primary lateral excavations and borings will occur at about the 1,200-foot level within the densely welded section of the Topopah Spring Member. Limited lateral excavations and borings will be performed at about the 520-foot level and the shaft bottom, 1,480 feet. The entire sequence of rocks to be penetrated by the ES lies above the water table, which occurs at a depth of about 1,780 feet.

The physical characteristics of the rock sequence to be encountered vary considerably with respect to compressive strength, in situ stresses, fracture frequency, and void space (lithophysal) content. Figure 3 is a graphic summary of the fracture frequency and void space content in the Topopah Spring Member from a depth of about 230 feet to about 1,400 feet. Discussion of compressive strength and in situ stresses throughout the rock sequence is beyond the scope of this presentation. However, based upon results of laboratory mechanical tests on core samples from drill holes at Yucca Mountain, a typical expected range for unconfined compressive strength values of Topopah Spring Member rock is 6,000 to 13,000 psi.

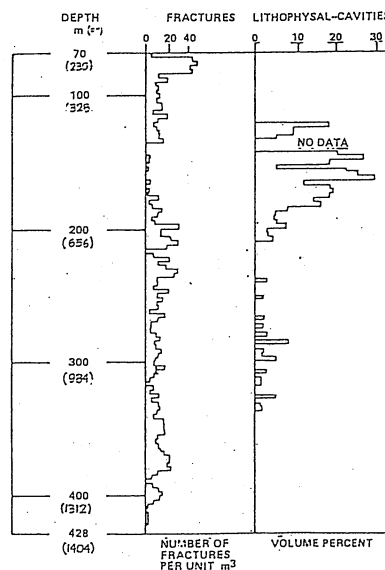

Figure 3. Fracture Frequency and Lithophysal Distribution (Ref. 1)

CONSTRUCTION METHOD DECISION

Preliminary planning and design for the ES focused primarily upon "big hole drilling" methods for the shaft sinking phase. An alternate method included in the planning was to use conventional mining techniques for the shaft sinking phase. Before planning and design could proceed beyond the preliminary stages, a major project decision on the shaft sinking method was required.

While many factors were considered during the construction method decision process, those which most influenced the decision were (1) personnel health and safety, (2) reliability of site characterization

technical data, and (3) cost and schedule. The first consideration continues to be of utmost importance to the ES construction contractor, REECO, and the Nevada Operations Office. The statistical advantage for health and safety in favor of drilling was recognized, but it did not offer a compelling argument for the selection of the drilling method. Discrimination on the basis of cost and schedule was not sufficient, especially because the planned depth was less than the water table depth. The second consideration, reliability of site characterization technical data, became the clearest discriminator between the two methods because of the technical concern about the extent to which construction fluid invasion could mask or alter the in situ hydrologic and geochemical conditions and parameters to be measured. While construction fluid is required for both drilling and mining operations, considerably more fluid is required for drilling. In addition to larger quantities, the fluid for large-diameter drilling would include bentonite and other chemical additives as opposed to the clear water for shot hole drilling in the conventional mining case. Shaft construction by mining also would allow direct observation of geologic and hydrologic conditions between the surface and the horizon of interest. Therefore, based primarily upon the above-mentioned considerations, conventional mining was selected as the method for shaft construction.

SYSTEM DESCRIPTION

The ES includes a surface facilities complex, an excavated, lined and equipped shaft, and lateral subsurface excavations and borings.

The surface facilities are located over a 15-acre site on the eastern slope of Yucca Mountain. The principal surface facilities contained within a three-acre contiguous, graded and stabilized pad area (see Figure 4) include a 5,000 kVA electrical substation; 3,000-square-foot prefabricated metal hoist house with two mine hoists; 80-foot-high structural steel, dual-sheave headframe; two 1,200-square-foot prefabricated metal shop and warehouse buildings; ventilation, compressed air, and emergency generator pads with associated equipment; two 700-square-foot portable change houses; and laboratory, office, and data acquisition trailers with associated equipment.

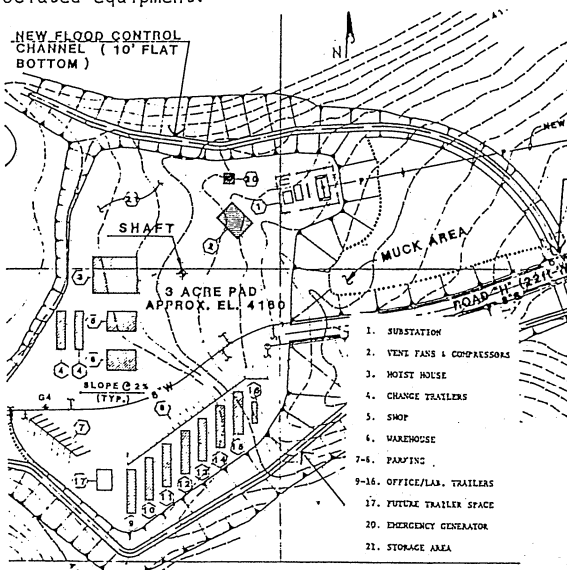

Figure 4. ES Site Plot Plan

The shaft, with a planned total depth of 1,480 feet, will be excavated to a diameter of 14 feet, lined with 12 inches of unreinforced concrete to a finished diameter of 12 feet and fitted with horizontal steel sets spaced at 10-foot intervals forming two separate hoisting compartments with nominal rectangular sections of 4 feet 6 inches by 5 feet 6 inches and 4 feet 10 inches by 5 feet 6 inches. A permanent ladderway and landings are separated from the hoisting compartments by steel mesh. Two 30-inch-diameter steel ventilation air ducts and steel conduits for compressed air, water supply and discharge, and instrumentation cables are included. (see Figure 5).

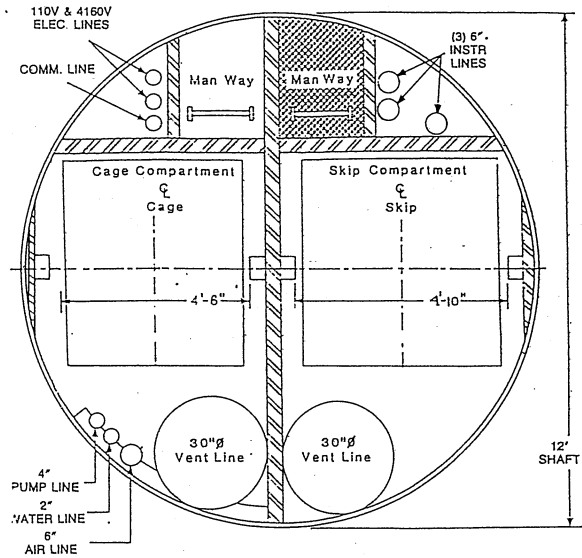

Figure 5. Shaft Section

Lateral subsurface excavations include (1) a primary test development at the 1,200-foot depth interval consisting of the equivalent of about 1,150 lineal feet of 15- by 15-foot drift and muck pocket with muck skip loading mechanism, (2) a limited test development at the 520-foot level consisting of about 100 lineal feet of 15-foot-high by 20- to 27-foot drift, and (3) a lower test level consisting of about 80 feet of 10-foot-high by 14-foot drift and a 32- by 20- by 14-foot-high drilling room (see Figures 6 and 7).

The total volume of rock to be removed from the shaft and lateral excavations is about 0.5 million cubic feet, which is equal to about 0.7 million cubic feet, to be hauled and stored at the surface based on a bulking factor of 1.4.

Lateral subsurface borings include (1) about 22,000 lineal feet of small-diameter (2- to 4-inch) hole, the majority of which is comprised of 500- to 2,300-foot-long core holes with an outside diameter of 2.98 inches and core diameter of 1.875 inches, and (2) 800 lineal feet of 30-inch-diameter simulated waste package emplacement hole.

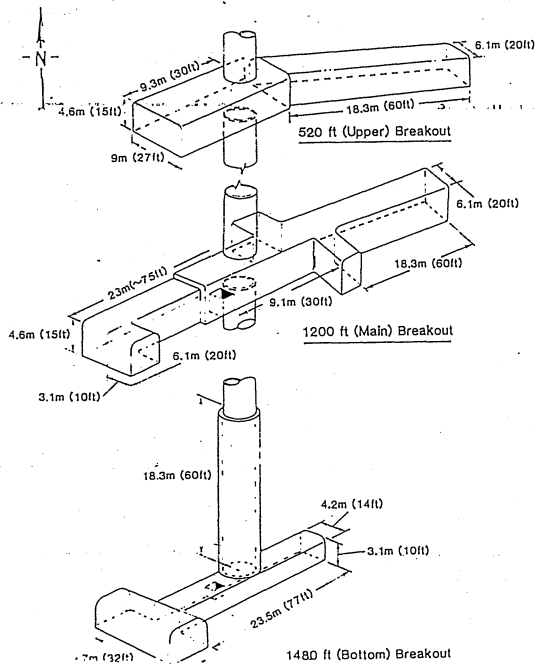

Figure 6. Lateral Subsurface Excavations

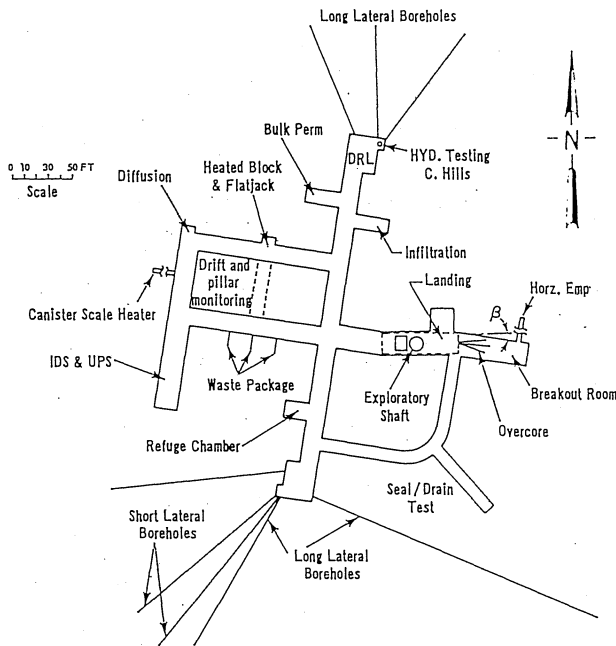

Figure 7. Primary Test Level Layout

SHAFT AND LATERAL EXCAVATION TECHNIQUES

The excavation sequence will commence with a crane and clamshell bucket to remove a combination of fill and unconsolidated alluvium to a diameter of about 16 to 17 feet and a depth of about 40 feet. Corrugated metal pipe with steel ring segments will be installed as excavation proceeds to hard rock where the shaft will be belled out with air hammers to about a 20-foot diameter. A steel reinforced 12-foot-inside-diameter section will be formed and

concrete placed to complete the shaft collar. Excavation will then proceed using drill-blast techniques with crane and clamshell removal of the broken rock (muck) to a depth of about 80 feet.

Segmented, circular, steel shaft liner forms and a multistage work platform (sinking deck) will be lowered into the 80-foot-deep excavation; the head-frame will be erected and hoist and sinking deck winch rigging completed. Subsequent shaft sinking operations consisting of shot-hole drilling, explosives loading, blasting, muck removal, and concrete liner placement (see Figure 8) will proceed sequentially to a depth of about 470 feet or 50 feet above the upper (limited) test level of 520 feet. Upon confirmation of the geologic conditions in the upper test level by vertical and horizontal coring of 100-foot-long holes using compressed air as the circulating fluid, the upper test level will be excavated using the drill, load, blast, and muck cycle with wall support provided by rock bolts and wire mesh.

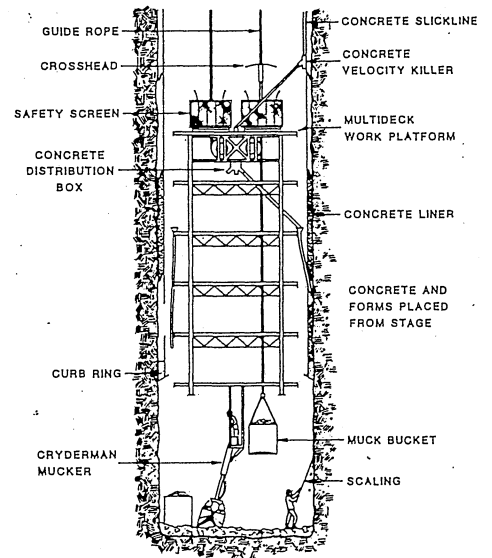

Figure 8. Shaft Sinking Process

Visual observations, mapping, and photography of the exposed rock walls will be conducted concurrently with the vertical and lateral excavation operations and the shaft internal steel will be installed as the mining face progresses. Special considerations during the excavation process include drilling, loading, and sequentially firing the shot holes in a manner to minimize wall damage and metering and chemically tagging all water used for the excavation.

A similar excavation sequence with planned stops for rock mechanics measurements will continue to the primary test level at about 1,200 feet, where a limited development and a 2,300-cubic-foot capacity muck pocket will be excavated and a muck skip loading mechanism installed for later use in excavating the remainder of the primary test level development. The shaft sinking sequence will then continue to the total depth of 1,480 feet similarly as above with

the exception of increasing the shaft diameter beginning at the transition from the Topopah Spring Member to the Calico Hills Member at about the 1,425-foot level. The increased diameter is necessary to accommodate an 18-inch-thick concrete liner section. The increased liner thickness below 1,425 feet is needed because the Calico Hills Member has an unconfined compressive strength about one-fifth that of the Topopah Spring. The bottom T-shaped excavation will then be completed, including wall stabilization with rock bolts and wire mesh to conclude the shaft sinking phase. The total estimated time for the shaft sinking phase from start of collar to completion of the bottom room is about 14 months.

Excavation of the primary test level will be performed using the conventional drill-blast-muck cycle as in the shaft sinking phase. The previously installed muck pocket and muck skip loading mechanism will be used in conjunction with a bottom dump muck skip specifically designed for the shaft muck haulage compartment. Both full-face mining and benching techniques will be used during the excavation, depending upon the size of the opening. The sequence for completing the various drifts and rooms has been developed to be compatible with the various tests to be conducted and installation of test hardware.

LATERAL BORING TECHNIQUES

Over one-half of the planned 22,000 lineal feet of lateral borings is contained in six 2,000-foot-long, NQ size (2.98-inch outside diameter by 1.88-inch core) holes to be drilled from the primary test level; and one 2,000-foot-long, NQ size, hole to be drilled from the shaft bottom. Current plans are to drill the holes using conventional wire line coring techniques utilizing diamond core heads and wire line retrievable core barrels. The retrievable core barrels allow removal of up to a 20-foot interval of cored rock without pulling the entire drilling string.

It is intended that the first 500 feet of these long core holes be drilled with compressed air as a circulating medium. The 500-foot cored section will then be reamed out and lined with cemented in place steel casing. The remainder of the coring will proceed with air-mist, foam, or bentonite based drilling mud. Further development and experimentation in coring with air as a circulating medium is planned prior to undertaking the work in the ES.

The large-diameter lateral borings to be performed in the ES consist principally of 30-inch diameter, 200- and 600-foot-long simulated waste package emplacement holes located in the 520- and 1,200-foot test levels, respectively. Development work for these large-diameter holes is being performed by Sandia National Laboratories (SNL). The 600-foot-long hole will represent a full-scale evaluation of the constructability of emplacement holes for a horizontal repository configuration in tuff.

The current concept for this test employs a non-rotating drill string with a cutter head assembly driven by an electric motor through a gear train housed within the drill string. Drill cuttings are removed by a vacuum collection system through a separate pipe attached to the exterior of the drill string. Hole alignment is to be monitored and maintained by a laser beam guidance system. The boring machine design must provide for placing a steel

liner inside the 30-inch diameter hole as it is being drilled, and the prototype to be used in the ES must be constructed of components which can be lowered through the largest shaft compartment which is nominally 5 feet by 5 feet 6 inches.

MATERIALS AND EQUIPMENT SPECIFICATIONS

General specifications for major materials categories and equipment items are as follows:

- Concrete--5,000 psi compressive strength in 28 days; Type II cement and 3/4-inch maximum aggregate size; typical mix proportions per cubic yard:

Cement	682 lbs.
Sand	1,292 lbs.
Aggregate	1,806 lbs.
Water	35 gal. (292 lbs.)

- Structural Steel--American Society for Testing and Materials (ASTM) designation, A-36; yield strength, 36,000 psi; ultimate tensile strength (min.), 58,000 psi:

- Rock Bolts--ASTM designation, A 615, Grade 60; yield strength, 60,000 psi, ultimate tensile strength (min.), 75,000 psi; deformed bar type to be anchored with polyester resin.

- Mine Hoists--One 900 hp, Vulcan Denver, single drum mine hoist with 6-foot diameter by 7-foot-wide drum and two 450 hp 4,160 volt, 710 rpm electric motors, rated at 1,350 fpm hoisting speed with 18,700 lbs. rope pull. One 400 hp, Vulcan Denver, single drum mine hoist with 5-foot diameter by 6-foot-wide drum and two 200 hp, 4,160 volt, 585 rpm electric motors, rated at 900 fpm hoisting speed with 12,500 lbs. rope pull.

- Headframe--One 80-foot-high, four post, ASTM A-36 steel, mine headframe complete with dump scrolls, dump chute, ladderway, 80-inch and 60-inch diameter sheaves, and 10,000-lb. monorail hoist beam. Structure rated for loading equal to a 200,000 lb. combined 1-inch and 7/8-inch hoist rope breaking strength.

- Conveyances--One personnel and materials cage with two steel grate decks rated for 500 lbs. per square foot loading; each with 7-foot clear headroom, enclosed with 1/8-inch expanded metal siding and equipped with safety latches to stop the fully loaded cage within 8 inches from free fall. Personnel capacity under normal conditions, 10; net weight 6,000 lbs.

One muck skip; bottom dump design; 1/4-inch plate steel body; volumetric capacity, 90 cubic feet of broken rock (~9,000 lbs.); with fold-down platform to provide for emergency personnel transport; net weight 6,750 lbs.

- Ventilation Fans--Two axial-vane, direct drive, reversible, electric motor driven fans; each capable of delivering 20,000 cubic feet of air (density-0.075 lbs./cubic feet) at a gauge pressure equivalent to a 20-inch column of water; nominal rating of each fan-motor set is approximately 100 hp.

8. Air Compressors--Two rotary screw type, electric motor driven, skid mounted compressors, each capable of delivering 1,500 cubic feet at 125 psi gauge.
9. Dewatering System--One 50 hp multistage, submersible, centrifugal pump at the shaft bottom; one 30 hp triplex, positive displacement pump at the 1,200-foot level and at the 520-foot level; and one 4-inch diameter, schedule 40 steel discharge line with associated check valves.

RELATED NEVADA TEST SITE EXPERIENCE

REECO, as the operating contractor at the NTS, has substantial experience in subsurface excavation and subsurface boring. That experience includes underground tunneling in both tuffaceous and granitic media. The recently completed (1980) Spent Fuel Test--Climax required the excavation of about 236,000 cubic feet of granitic material and drilling 3-inch diameter core holes up to 500 feet in length.

The previous NTS excavation and drilling experience in tuff and granite has provided lessons which could be of significant benefit during the construction of the ES.

REFERENCES

Figures 2 and 3: Spengler, Richard W., and Chornack, M. P., with a section on geophysical logs by Muller, D. C., 1984, Stratigraphic and Structural Characteristics of Core Hole USW G-4, Yucca Mountain, Nye County, NV, USGS Open File Report (in preparation).